

Article number: 604140014009

Description: Timing belt pulley with hub
HTD 14 3M 9

Measures

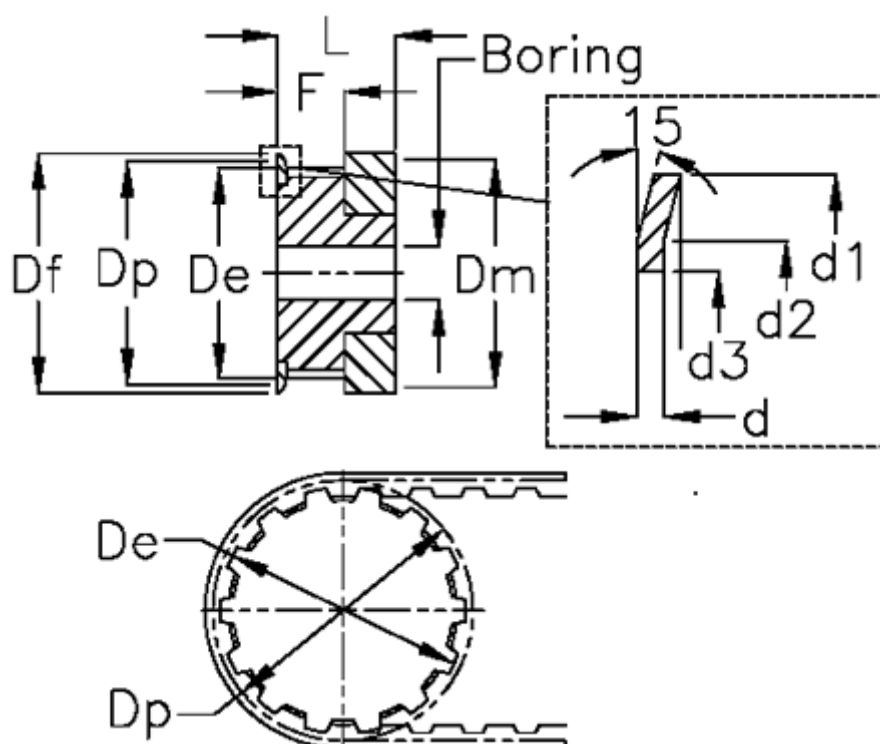

Bore = 4	Dp = 13.37
d = 0.5	F = 10.2
d1 = 16	Flange type = F03
d2 = 13	L = 17.5
d3 = 9.5	Tooth number = 14
De = 12.61	Type = 3M
Df = 16	Weight = 0.007
Dm = 16	Width = 09